



**KOLMEKS**  
EFFICIENT RELIABILITY

SERIES

AE\_-,  
L\_-,  
AL\_-,  
T- and  
AT-

OPERATING INSTRUCTIONS

CENTRIFUGAL PUMPS WITH INTEGRATED FREQUENCY CONVERTER

FC\_ -SERIES



# Content

1. General.....	3
1.1 Symbols.....	3
1.2 Applications.....	3
1.3 Manufacturer.....	3
1.4 Version.....	3
2.1 Handling, transport and storage of the pump.....	4
2. Handling, transport and storage of the pump.....	4
3. Design and function.....	4
3.1 Construction.....	4
3.2 Technical data.....	4
3.3 Rating plate.....	5
3.4 Pump identification.....	5
4. Safety.....	6
4.1 Safety instructions.....	6
4.3 Elements of danger if safety regulations are not obeyed.....	6
4.4 Safety instructions for inspection and assembly.....	6
4.2 Training.....	6
4.5 Operating the pump.....	6
5. Installation, introduction and start-up.....	6
5.1 General.....	6
5.2 Positions for installation.....	7
5.3 Electrical connections.....	7
5.4 Control methods and connections.....	8
5.4.1 I/O's of the FC-pump (inputs and outputs).....	8
5.4.2 Factory settings.....	8
5.4.3 FCA -pump - speed reference from potentiometer.....	9
5.4.4 FCB -pump - constant pressure between the pump flanges.....	10
5.4.5 FCC -pump - constant pressure between inlet- and outlet-line.....	11
5.4.6 FCCVAK -pump - constant pressure between supply- and return-line with external controller in use (SETUP 1).....	12
5.4.7 FCCVAK -pump - constant pressure between supply- and return-line with controller of the frequency converter in use (SETUP 2).....	13
5.4.8 FCD -pump - constant pressure in discharge flange.....	14
5.4.9 FCE -pump - sensorless, pre-programmed pump curves.....	15
5.4.10 FCF -pump - constant temperature.....	16
5.4.11 FCF -pump - the speed according to temperature.....	17
5.4.12 FCG -pump - controlled by external system.....	18
5.4.13 Connections to the alarm receiving station.....	19
5.4.14 Local control panel (optional).....	20
6. Service, spare parts and troubleshooting.....	22
6.1 Shaft seals.....	22
6.2 Other parts.....	22
6.3 Troubleshooting.....	23
7. Declaration of Conformity.....	27

# 1. General

## 1.1 Symbols



Warns that failure to observe the precaution may cause personal injury or damage to property.



Indicates something to be noted by the reader.



Warns that failure to observe the precaution may cause electric shock

## 1.2 Applications

The most common applications are heating, air condition, cooling systems. Also heat exchangers, pressure boosting systems, district heating systems, ice halls, public baths and industrial processes.

Pump series	Applications
<b>AE-, L-, AL-, T-, AT-</b>	Clean, thin, non-aggressive liquids. - circulating water in for heating and cooling systems - water-glycol mixtures. Recommendation: propylene glycol - nominal pressure 10 bar.
<b>L-, ALH-</b>	- like in L- and AL -series, but nominal pressure 16 bar.
<b>AEP-, LP-, ALP-</b>	Clean, thin, slightly aggressive liquids. - domestic water, oxygen rich waters - nominal pressure 10 bar.
<b>LS-, ALS-</b>	Aggressive, thin, not bigger solid particles containing liquids - in addition to above mentioned liquids various acids, salts, oxidizing and chemically active organic fluids - nominal pressure 16 bar.
<b>All types of FC-pumps</b>	Temperature range: -10 ... + 95 °C (continuous + 80°C) Max. temperature of environment +40°C (diurnal average max. +35°C)



Suitability of materials and seals for pumped liquid shall be always checked between purchaser and supplier.



The nominal pressure and the max. temperature of pumped liquid are stamped on the pump rating plate. Never use the pump in any other application or conditions without manufacturer's acceptance. In the case of damage there may be danger to persons by having poisoning, burns, wounds etc. depending on the pumped liquid and it's temperature and pressure. The pump surface temperature may cause danger depending on the working conditions.

## 1.3 Manufacturer

This product is manufactured by OY KOLMEKS AB, P.O.BOX 27, FIN-14201 TURENKI, FINLAND.

## 1.4 Version

Release date of this manual is 04.01.2005. This is version no. 5.

## 2. Handling, transport and storage of the pump

### 2.1 Handling, transport and storage of the pump



Normally the pumps are stable when they are transported and don't go down even they are bent 10°. Pumps shall be stored in a dry and cool place protected from dust. Temperature of environment must be in -10 °C ... +50°C. It is not allowed to lift the pump from frequency converter. In the case of longer storage time or the pump serves as a stand-by, it is recommended to rotate the pump manually f.ex. from the motor fan at least once a month.

## 3. Design and function

### 3.1 Construction

The pump and motor constitute a unit, where the rotating parts of both the pump and the motor are on the same shaft (mono-block design). The motor is of a dry type and the frequency converter is integrated to the electric motor.

Electric motor: Totally enclosed, fan cooled A.C. motor, with frequency converter.  
 Protection form: IP54  
 Insulating class: F

### 3.2 Technical data

Pump type	Flanges	Weight kg <sup>*</sup>	Max. input power kW	Nominal current A (400 V)	Twin pump
AE_-25/4,-26/4FC_	G 1	15	0,27	0,53	-
AE_-25/2,-26/2FC_	G 1	20	0,85	1,5	-
AE-32/4, -33/4FC_	G 11/4	20	0,5	0,9	-
AE-32/2, -33/2FC_	G 11/4	20	1,5	2,6	-
L_-32A/4FC_	DN32	19	0,27	0,53	T-32A/4FC_
L_-32A/2FC_	DN32	25	0,85	1,5	T-32A/2FC_
L_-40A/4FC_	DN40	25	0,5	0,9	T-40A/4FC_
L_-40A/2FC_	DN40	29	1,5	2,6	T-40A/2FC_
L_-50A/4FC_	DN50	33	0,7	1,4	T-50A/4FC_
L_-50C/2FC_	DN50	49	2,5	4,5	T-50C/2FC_
L_-65A/4FC_	DN65	47	0,7	1,4	T-65A/4FC_
L_-65A/4FC_	DN65	56	1,6	2,6	T-65A/4FC_
L_-65A/4FC_	DN65	67	2,8	4,7	T-65A/4FC_
L_-65B/2FC_	DN65	69	4,3	6,9	T-65B/2FC_
L_-65B/2FC_	DN65	100	8,0	12,4	T-65B/2FC_
L_-80A/4FC_	DN80	48	0,7	1,4	T-80A/4FC_
L_-80A/4FC_	DN80	62	1,6	2,6	T-80A/4FC_
L_-80A/4FC_	DN80	76	3	4,9	T-80A/4FC_
L_-80A/2FC_	DN80	74	4,3	6,9	T-80A/2FC_
L_-80A/2FC_	DN80	105	8,0	12,4	T-80A/2FC_
AL_-1032/4FC_	DN32	25	0,5	0,9	T-40A/4FC_ (DN40)
AL_-1032/2FC_	DN32	29	1,5	2,6	T-40A/2FC_ (DN40)
AL_-1066/4FC_	DN65	47	0,7	1,4	T-65A/4FC_
AL_-1066/4FC_	DN65	56	1,6	2,6	T-65A/4FC_
AL_-1066/4FC_	DN65	67	2,8	4,7	T-65A/4FC_
AL_-1065/2FC_	DN65	69	4,3	6,9	T-65B/2FC_
AL_-1065/2FC_	DN65	100	8,0	12,4	T-65B/2FC_
AL_-1081/4FC_	DN80	62	1,6	2,6	T-80A/4FC_
AL_-1081/4FC_	DN80	76	3	4,9	T-80A/4FC_
AL_-1081/2FC_	DN80	74	4,3	6,9	T-80A/2FC_
AL_-1081/2FC_	DN80	105	8,0	12,4	T-80A/2FC_
AL_-1102/4FC_	DN100	70	1,6	2,6	AT-1102/4FC_
AL_-1102/4FC_	DN100	86	3,7	5,8	AT-1102/4FC_
AL_-1106/4FC_	DN100	170	4,4	7,2	AT-1129/4FC_
AL_-1106/4FC_	DN100	200	8,3	13,0	AT-1129/4FC_
AL_-1129/4FC_	DN125	175	4,4	7,2	AT-1129/4FC_
AL_-1129/4FC_	DN125	205	8,3	13,0	AT-1129/4FC_

Noise level of all pump types is under 70 dB (A, 1 m).

<sup>\*</sup> Single pump weight (AL). The weight of the twin pump (T/AT) is depending on the size of the motor and equipment each unit. The weight of the twin pump is about two times the single pump weight.

### 3.3 Rating plate

Shows the information about the electric motor and also design data of the pump.

Type LP-50A/4FCC1045 S6 K2 V1-C320001					
No. 123456/04		PN 10		Ø 135 PM	
5 l/s	4 m	+95 °C	PI 0,45 kW		
Motor OKFC-100 B2 F15					
3~ 50 Hz	400 V	1,4 $\beta$ max	PI max 0,70 kW		
IP54	5 - 30 r/s	S1		CE	
OY KOLMEKS AB Finland				Isol.F	

### 3.4 Pump identification

#### Pump series:

- L\_ = single in-line pump, with flanges
- AL\_ = single in-line pump, with flanges
- AT,T = twin in-line pump, with flanges
- AE = single in-line pump, with pipe connection

#### Material of pump housing, sealing flange and impeller / nominal pressure of the pump:

- no letter = grey cast iron EN-GJL-200 / 10 bar
- H = nodular cast iron EN-GJS-400 / 16 bar
- P = bronze CuPb5Sn5Zn5 / 10 bar
- S = stainless steel AISI 316 / 16 bar

#### Flange sizes:

AE_:	AL_/AT:	L_/T:
25/26 = G 1	x03 = DN 32	40 = DN 40
32 = G1 1/4	x05 = DN 50	50 = DN 50
	x06 = DN 65	65 = DN 65
	x08 = DN 80	80 = DN 80
	x10 = DN 100	100 = DN 100
	x12 = DN 125	125 = DN 125

#### Version number (AL/AT) or letter (L\_ /T)

#### Poles of the electric motor:

- 2 = rotation speed 50 r/s (50 Hz)
- 4 = rotation speed 25 r/s (50 Hz)
- rotation speed 30 r/s (60 Hz)

#### FC = the frequency converter is integrated to the motor

#### Control method:

A, B, C, D, E, F, G (please check 5.4 Control methods and connections)

#### The range of the pressure (difference) transmitter:

Example:  
10 = 0 - 1 bar  
60 = 0 - 6 bar

#### Control range (depending on pump type):

Example:  
45 = 0,5 - 4,5 m  
80 = 0,5 - 8 m  
20 = 2 - 20 m  
60 = 1 - 6 bar

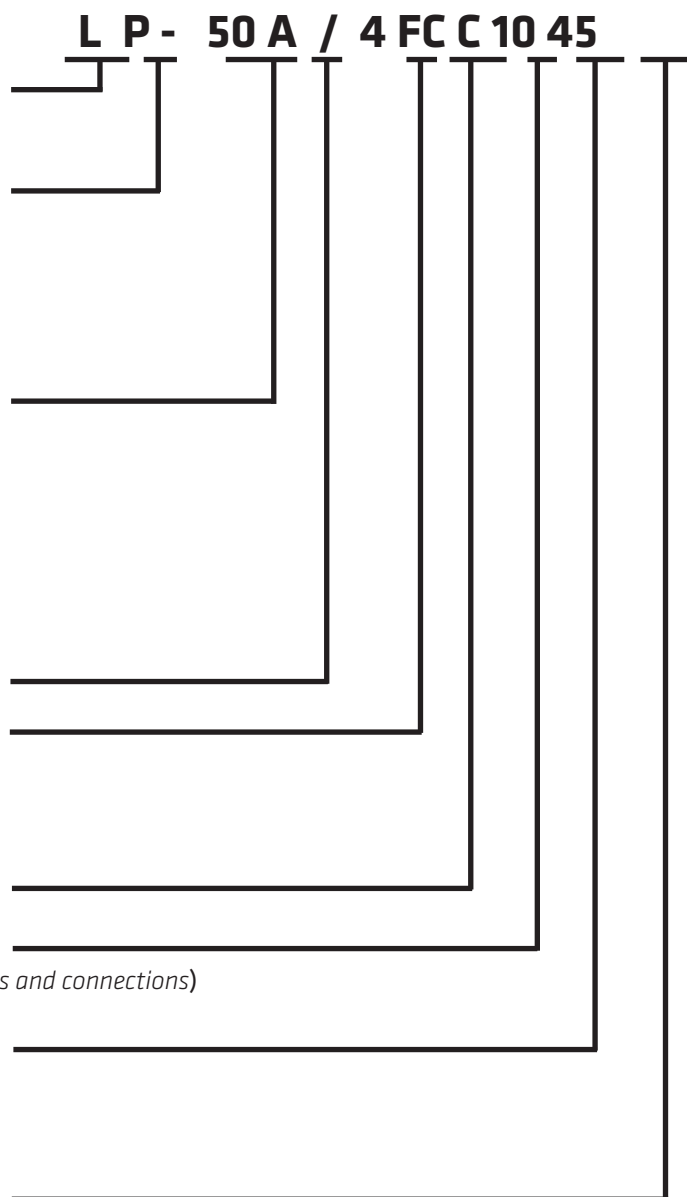

## 4. Safety

This manual includes important information concerning installation and operating the pump. Persons who are involved in installation or/and operation of the pump, should read and understand these instructions before installation or starting the pump.



There are live parts inside the frequency converter, when the supply voltage is connected. Incorrect installation may cause damage to the pump or bodily injuries, even death. Touching the live parts may be mortal even the supply voltage is disconnected. **Wait at least 4 minutes!** Obey instructions of this manual and national and local requirements and standards.

- installation must be protected by fuses and insulated correctly.
- covers and cable inlet must be installed.



Attention:

It is user's or certified electrician's responsibility to ensure the correct earthing and protection in accordance with applicable national and local requirements and standards.

### 4.1 Safety instructions

1. FC-pump must be disconnected from the mains if repair work is to be carried out. Check that the mains supply has been disconnected and necessary time has passed (at least 4 minutes).
2. The device must be connected correctly to the earth. User must be protected from supply voltage and the pump must be protected from short circuit according to the national and local requirements and standards. The overload protection is included in FC -pump.
3. Earth leakage is more than 3,5 mA. It means, that installation of supply cable must be fixed.

### 4.2 Training

The persons who have responsibility for installing or/and operating the pump, should be trained.

### 4.3 Elements of danger if safety regulations are not obeyed

If the safety regulations are not obeyed, personal injuries or damage to the pump or related devices may occur. Validity safety instructions must be obeyed.

### 4.4 Safety instructions for inspection and assembly

It is user's responsibility to ensure that persons who carry out inspections and installations are qualified experts and familiarized themselves with these instructions carefully.

### 4.5 Operating the pump

Working safety of the delivered pump and related devices can be ensured only if these devices are operated according to the section *1.2 Applications* of this manual.

## 5. Installation, introduction and start-up

### 5.1 General

The position of the motor unit with the frequency converter can be changed by removing the motor unit from the pump housing and setting it to the desired position (not in LH- and ALH-serie and in FCB, FCC ja -FCD-types with certain limitations).

When installing the pump pay attention to the following:

- space enough for service and inspection of the pump
- free visibility to the scale of the potentiometer and curve plate of the pump.
- possibility to use lifting mechanism if needed
- shut-off valves on the both sides of the pump
- the frequency converter is not too close hot pipes.

## 5.2 Positions for installation

### Allowed positions

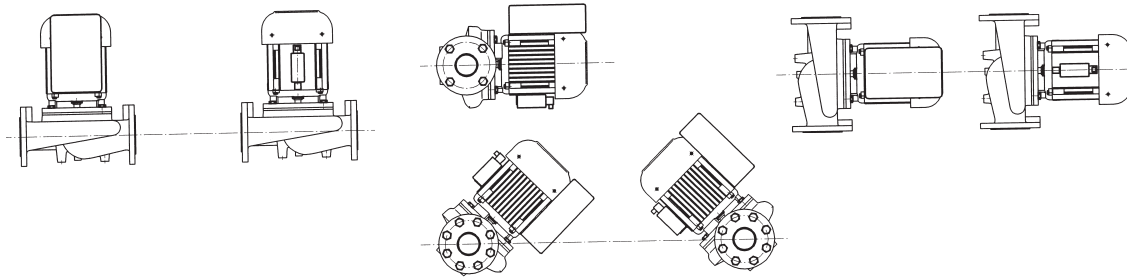

**Allowed positions**, if the pipes of the pressure difference transmitter are not installed to the flanges of the pump

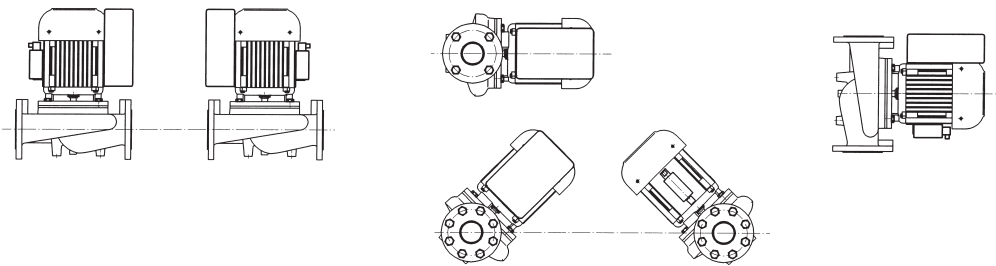

### Not allowed positions

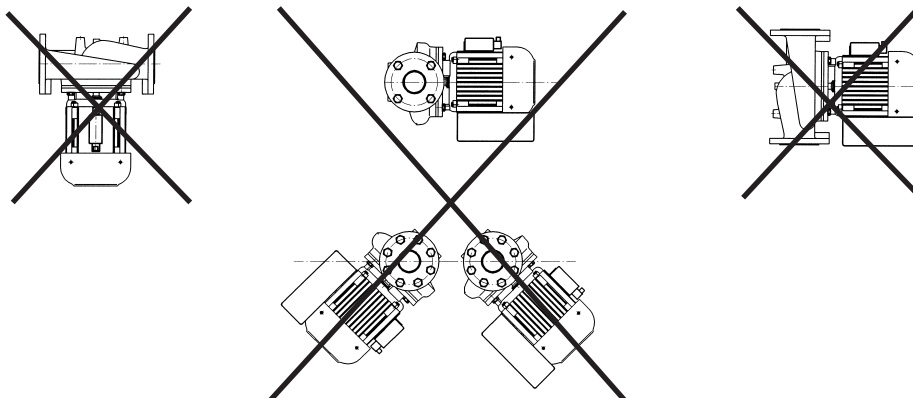

## 5.3 Electrical connections



All electrical work shall be carried out by qualified electrician approved by the local authorities. Supply voltage may be connected with standard cable, screened cable is not required. Ensure, that the nominal voltage of the electric motor corresponds the local supply voltage.

### ATTN

Use always screened control cables.

Before starting the pump fill and vent the system. Make sure that the pump rotates freely by rotating it manually f.ex. from the motor fan. Never start or let the pump run dry.

Before starting the pump fill and vent the system. After starting make sure that there is no extra noise coming from the pump and that no leakages appear.

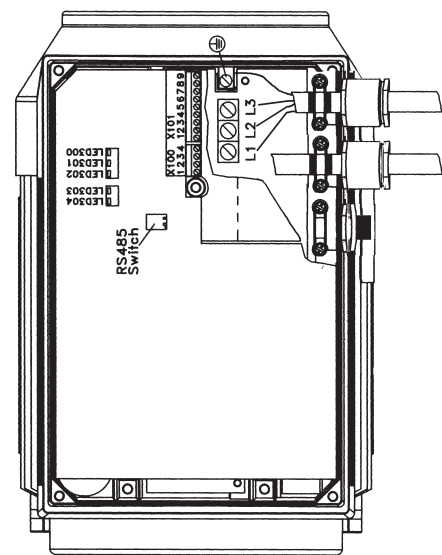

## 5.4 Control methods and connections

### 5.4.1 I/O's of the FC-pump (inputs and outputs)

<b>Terminal 1 / X101</b>	analog input 0-20 or 4-20 mA (different possible functions)
<b>Terminal 2 / X101</b>	analog input 0-10V or digital input (different possible functions)
<b>Terminals 3, 4 and 5 / X101</b>	digital input (different possible functions)
<b>Terminal 6 / X101</b>	24 V DC supply for digital inputs and feedback (max. 150 mA )
<b>Terminal 7 / X101</b>	10 V DC supply for potentiometer (max. 15 mA )
<b>Terminal 8 / X101</b>	0 V for terminals 1-7 ja 9
<b>Terminal 9 / X101</b>	analog or digital input (different possible functions,
<b>Relay output: Terminals 1, 2 and 3 / X102</b>	relay output (different possible functions), potential free change-over contacts, max. 250 V / 5 A

### 5.4.2 Factory settings

**Terminal 1 / X101.** *No operation (setup1) or Feedback 4-20 mA (setup2) depending on selected control method.*

**Terminal 2 / X101.** *Speed reference 0-10V (setup1) or Reference of controller 0-10V (setup2) depending on selected control method.*

**Terminal 3 / X101.** Setup selection. Terminals 6-3 open/closed means setup1/setup2 selected. If setup1 is selected, *speed reference 0-10V* is connected to the terminals 2-8 with potentiometer or external signal. The speed of the pump is controlled according to the voltage signal. If the voltage is selected with potentiometer, the speed is constant. When Setup2 is selected the controller of frequency converter is in use. The *reference of controller 0-10V* is connected to the terminals 2-8 with potentiometer or external signal. Feedback signal 4-20 mA is connected to the terminal 1. The speed of the pump changes according to the need of regulation.

**Terminal 4 / X101.** Stop / Start. Terminals 6-4 open means pump is not running, closed means pump is running.

**Terminal 5 / X101.** Reference freeze (both setup's). When terminals 5 and 6 are connected, the speed reference (setup 1) or the reference of the controller (setup 2) is frozen (not possible to change with potentiometer). By disconnecting the wire between terminals 5 and 6, reference (0-10V) to the terminal 2 / X101 is in use.

**Terminal 9 - (8) / X101.** Digital output signal (24VDC, max. 25 mA) - *fault*. The voltage in terminal indicates the fault in the pump / inverter. Voltage is zero, if the supply voltage is not connected or there is no fault. If the potential free contact is needed, the separate relay (24 VDC, < 25 mA) is needed. Please check the wiring diagram in section 5.4. This terminal is possible to program with separate local control panel (not included in standard delivery) to an other digital or analog output. E.g. 0 (4) - 20 mA analog output for frequency, reference, feedback, etc.

**Relay output: Terminals 1, 2 and 3 / X102.** Terminals 1 and 2 are connected when motor is running. Terminals 1 and 3 are connected when motor is not running (or the supply voltage is not connected).



### 5.4.3 FCA -pump - speed reference from potentiometer

#### Applications

Systems, where the duty point remains constant and where is no need for continuous automated regulation.

#### Accessories

Pump, frequency converter and potentiometer.

#### Operation principle

The speed of electric motor can be adjusted manually at the site. Useful feature for commissioning of the pump. The pump will run with constant speed. The reference can be freed by connecting wire between terminals 5 and 6.

**ATTN** Mark the position of the potentiometer to the sticker in cover of the frequency converter.

#### Pump curve

QH-curve of the pump is equal with that of single speed pump.

#### Standard control connections

**FACTORY DEFAULT: SETUP 1**

**SETUP 1 = speed reference (FCA)**

**SETUP 2 = controller of the frequency converter in use, e.g. FCB, FCC**

X101

Fault, dig output	24VDC/25mA	9
0 V		8
+ 10 V		7
+ 24 V		6
<b>SETUP 1</b> Speed Reference	<b>SETUP 2</b> Feedback Control	
No reference freeze: jumper 6-5 disconnected Reference freeze: jumper 6-5 connected	No reference freeze: jumper 6-5 disconnected Reference freeze: jumper 6-5 connected	5
Stop: jumper 6-4 disconnected Run: jumper 6-4 connected	Stop: jumper 6-4 disconnected Run: jumper 6-4 connected	4
Setup1 selected: jumper 3-5 disconnected	Setup2 selected: jumper 3-6 connected	3
Speed Reference: Scale: 0-10V, 10- max. Hz	Reference: 0-10 V	2
Not in use	Feedback: 4-20 mA	1

External relay (not included in standard delivery)

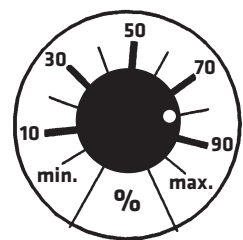
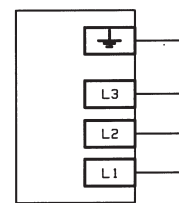
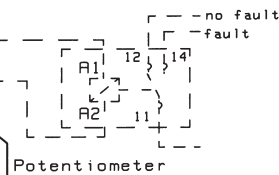

An example of curve plate of FCA -pump.

X100

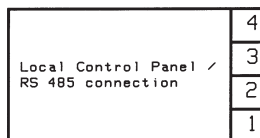

X102

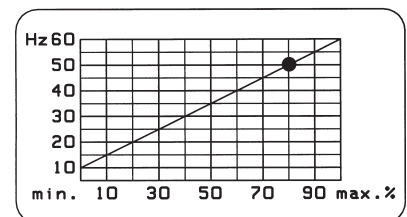
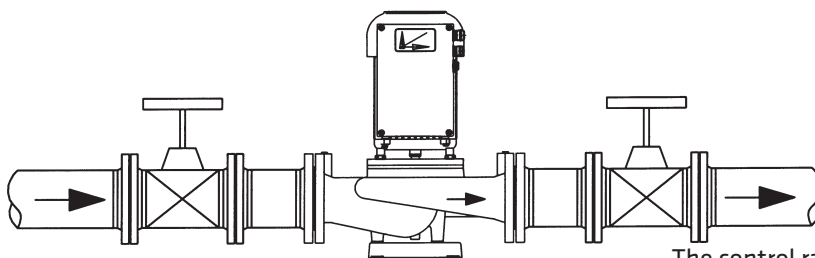
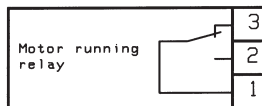

The control range is shown in curve plate which is located in cover of the frequency converter.

## 5.4.4 FCB -pump - constant pressure between the pump flanges

### Applications

Systems, where are variations in the flow and where pressure losses are generated mainly on the consumption equipment. Heating circulation, where the pressure loss on the heat exchanger is small.

### Accessories

Pump, frequency converter, potentiometer and differential pressure transducer with pipes to the pump flange.

### Operation principle and flow adjustment

The level of the constant pressure difference between the pump flanges can be adjusted by potentiometer. The set value for the pressure difference can be found from the curve plate of the pump. The pump will run with variable speed. When adjusting the flow of the system, the main control valve must be opened as open as possible and then the flow is adjusted by potentiometer. The reference can be frozen by connecting wire between terminals 5 and 6.

**ATTN** Mark the position of the potentiometer to the sticker in cover of the frequency converter.

### Pump curve

QH-curve of the pump is controlled to a horizontal line.

### Standard control connections

#### FACTORY DEFAULT: SETUP 2

**SETUP 2 = constant pressure difference (FCB, controller of the frequency converter in use)**

**SETUP 1 = speed reference (FCA)**

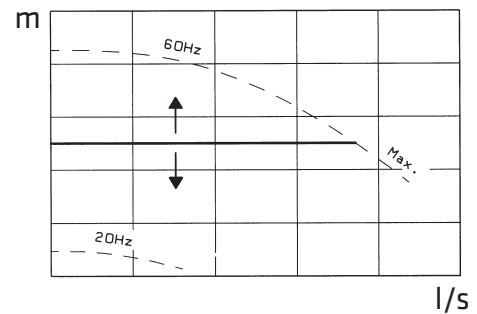
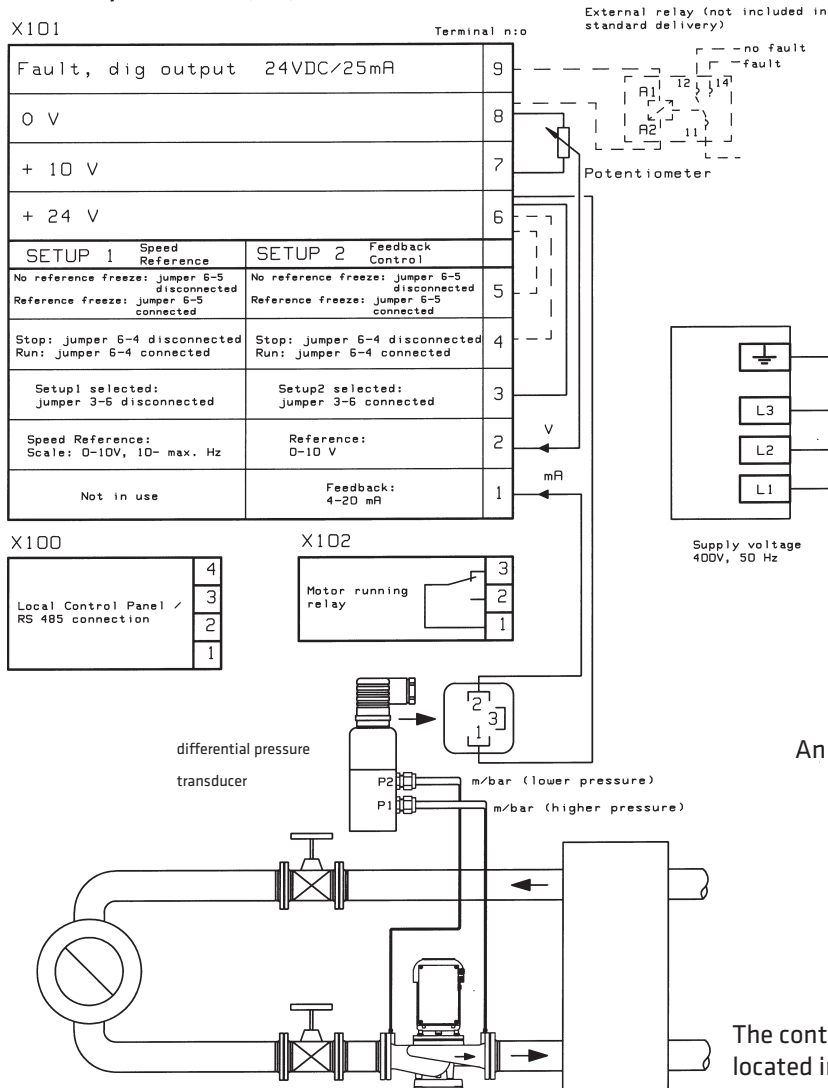

By disconnecting the wire from potentiometer to the terminal 2 and connecting the external 0-10V signal to the terminals 2-8, the reference for pressure difference is given externally. Please check section 5.4.7.

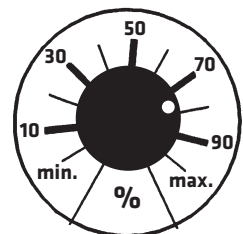

An example of curve plate of FCB -pump.

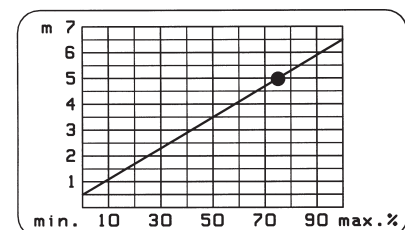

The control range is shown in curve plate which is located in cover of the frequency converter.

## 5.4.5 FCC -pump - constant pressure between inlet- and outlet-line

### Applications

Systems, where are variations in the flow and where pressure losses are generated mainly on the source of heat equipment. Heating and cooling circulations and the pressure boosting of parallel circulations.

### Accessories

Pump, frequency converter, potentiometer and differential pressure transducer with pipes. One pipe to be installed to the suction or pressure flange of the pump and the another one on to the system, inlet or outlet pipe.

### Operation principle and flow adjustment

The level of the constant pressure difference between the inlet- and outlet-line of the system can be adjusted by potentiometer. The set value for the pressure difference can be found from the curve plate of the pump. The pump will run with variable speed. When adjusting the flow of the system, the main control valve must be opened as open as possible and then the flow is adjusted by potentiometer. The reference can be frozen by connecting wire between terminals 5 and 6.

**ATTN**

Mark the position of the potentiometer to the sticker in cover of the frequency converter.

### Pump curve

QH-curve of the pump is controlled to a quadratic. The relation of pressure loss in the source of heat (cold) to the loss in the system defines the shape of the curve. When the losses in the heat exchanger are large part of the whole losses in the system the curve is more steep.

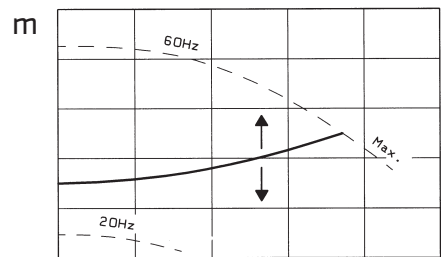

l/s

### Standard control connections

#### FACTORY DEFAULT: SETUP 2

**SETUP 2 = constant pressure difference (FCC, controller of the frequency converter in use)**

**SETUP 1 = speed reference (FCA)**

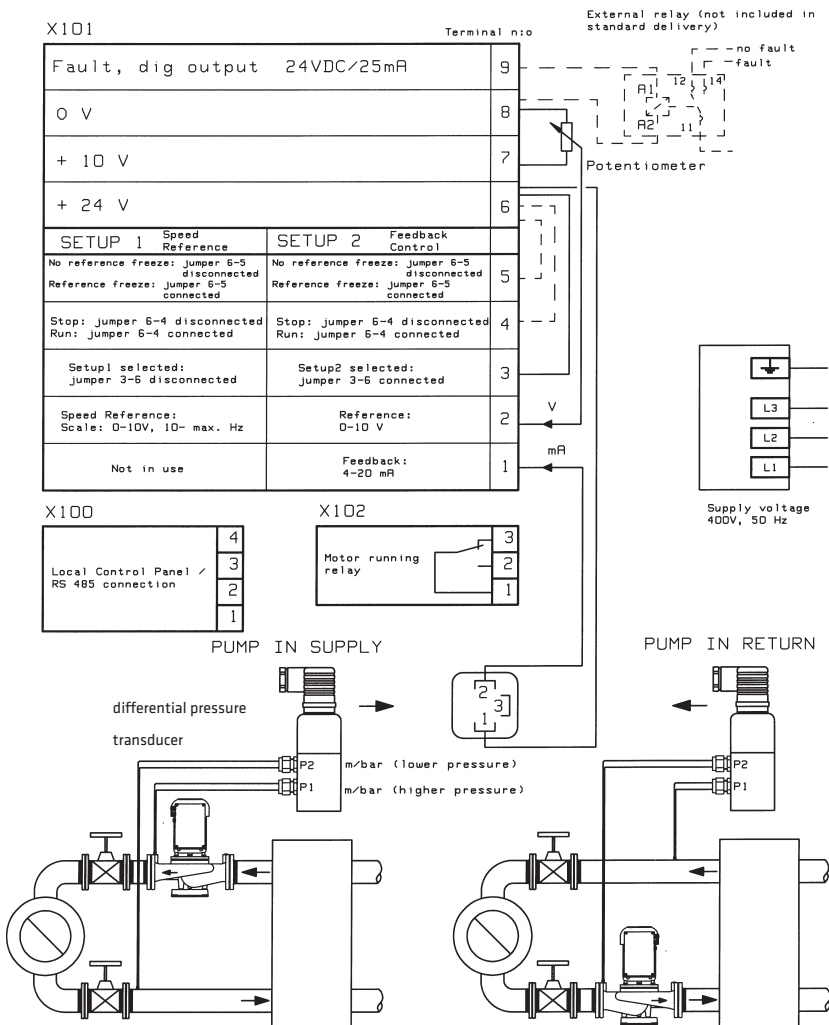

By disconnecting the wire from potentiometer to the terminal 2 and connecting the external 0-10V signal to the terminals 2-8, the reference for differential pressure is given externally. Please check section 5.4.7.

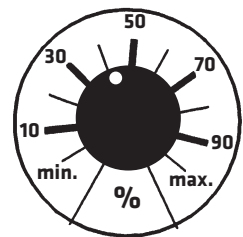

An example of curve plate of FCC -pump.

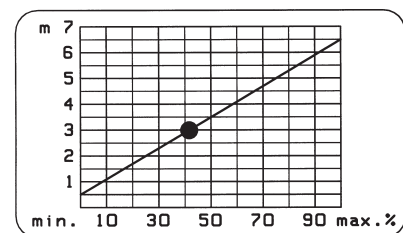

The control range is shown in curve plate which is located in cover of the frequency converter.

## 5.4.6 FCCVAK -pump - constant pressure between supply- and return-line with external controller in use (SETUP 1)

### Operation principle (speed reference 0-10 V for pump)

The level of the constant pressure difference between the inlet- and outlet-line of the system can be adjusted by external control system (speed reference 0-10 V to the terminal 2).

### Flow adjustment and balancing the system

Before adjusting and balancing the system the differential pressure transducer is connected to the external control system. The main control valve must be opened as open as possible and then the flow is adjusted by potentiometer, which is connected to the terminal 2 (constant speed) to replace external speed reference while adjusting and balancing the system. When the system has adjusted and balanced, the value of the pressure difference is read and saved to the control system as a reference value.

Alternatively the correct pressure difference value can be adjusted with potentiometer when the pump is connected as a standard FCC -pump (check the previous page). When the system has adjusted and balanced, the reference of the pressure difference (m) can be read from the scale of the potentiometer (e.g. 20 % = 1.7 m), which is then saved as a reference value to the external control system.

### Check and update the connections!

### Standard control connections

#### FACTORY DEFAULT: SETUP 1

**SETUP 1 = speed reference from external controller (FCCVAK1)**

**SETUP 2 = reference for differential pressure from external control system (controller of the frequency converter is in use, FCCVAK2)**

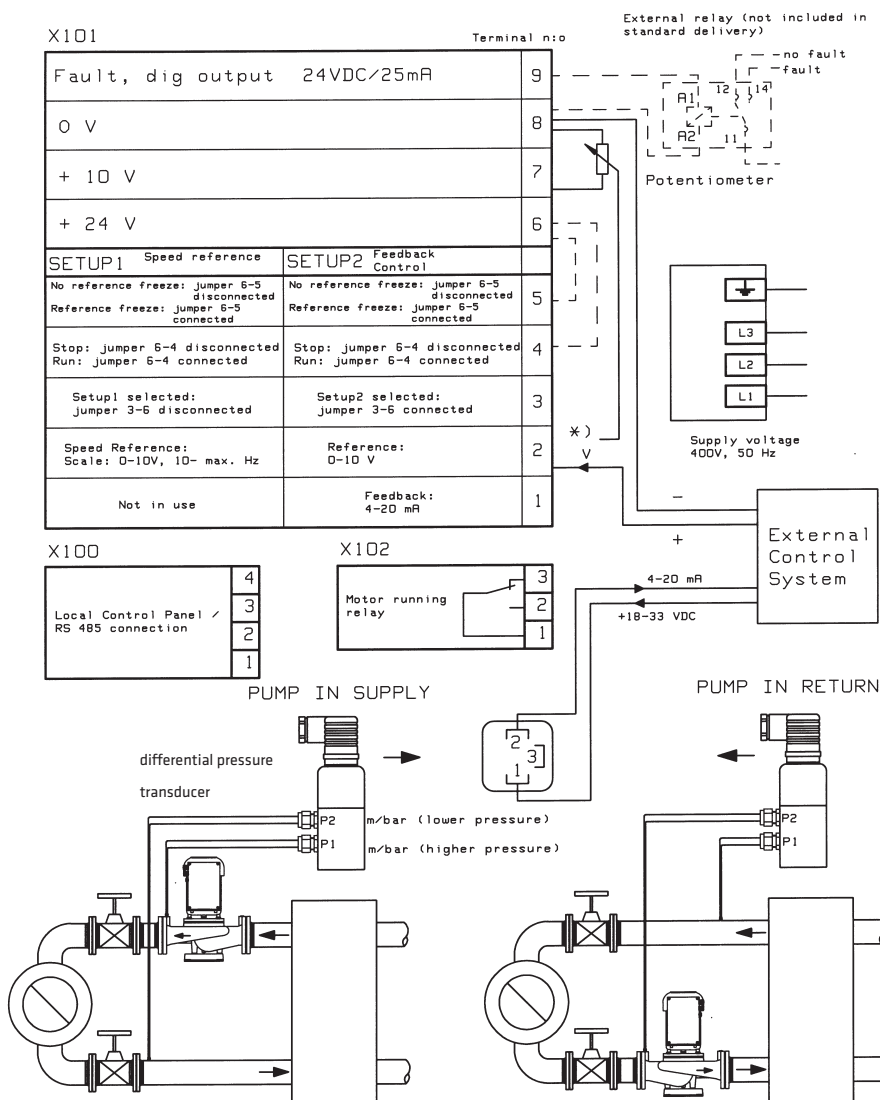

In the cover of the frequency converter is curve plate, where the set value for the pressure difference can be found in ratio (%) to the range of the reference of the pressure difference and to the position of the potentiometer. Curve plate is valid, when setup2 is selected, terminal 6-3 is closed. According to the factory default, the setup1 is selected, speed reference 0 V corresponds the minimum speed and 10 V corresponds maximum speed. The rotation speed unit is r/s, which is marked in the rating plate. The corresponding frequencies are minimum 10 Hz and maximum 50 or 60 Hz. The datasheet, where the pump curves can be read with different frequencies, is also delivered with this version.

The switch in external control system between terminals 4-6 väliin (e.g. automatic summer stoppage).

\*) When pump is delivered from the factory, the wire of the potentiometer is connected to the terminal 2 then the pump can be operated as FCA -pump. By disconnecting the wire and connecting the external voltage signal to the terminal 2, the pump is controlled externally.

An example of curve plate of FCCVAK -pump.

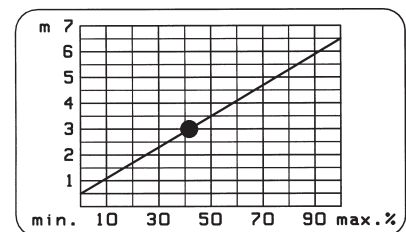

The control range is shown in curve plate which is located in cover of the frequency converter.

## 5.4.7 FCCVAK -pump - constant pressure between supply- and return-line with controller of the frequency converter in use (SETUP 2)

### Operation principle (reference for pressure difference 0-10 V for pump)

The level of the constant pressure difference between the inlet- and outlet-line of the system can be adjusted by external control system (reference for differential pressure 0-10 V to the terminal 2). The operation and connections are the same like in FCC -pump (section 5.4.5), except the reference for pressure difference is given from the external control system.

### Standard control connections

#### FACTORY DEFAULT: SETUP 2

**SETUP 2 = reference for differential pressure from external control system (controller of the frequency converter is in use, FCCVAK2)**

**SETUP 1 = speed reference from external controller (FCCVAK1)**

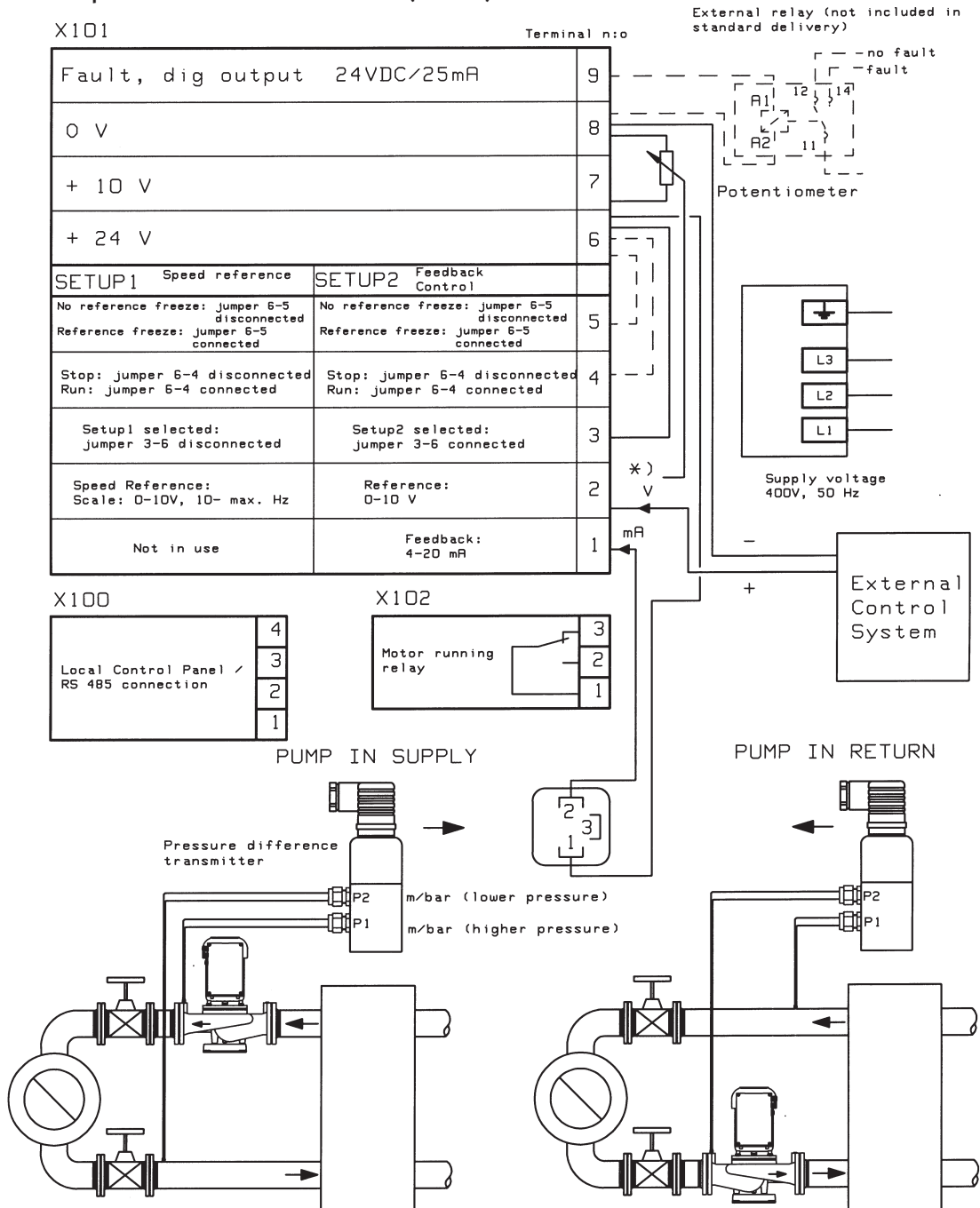

The switch in external control system between terminals 4-6 (e.g. automatic summer stoppage).

\*) When pump is delivered from the factory, the wire of the potentiometer is connected to the terminal 2 then the pump can be operated as FCA -pump. By disconnecting the wire and connecting the external voltage signal to the terminal 2, the pump is controlled externally.

## 5.4.8 FCD -pump - constant pressure in discharge flange

### Applications

Pressure boosting or other open systems, where constant pressure is required.

### Accessories

Pump, frequency converter, potentiometer and pressure transmitter with pipes. The pressure transmitter is installed to the pressure flange of the pump or near to the consumption in the pipe line.

### Operation principle

The level of the constant pressure on the pressure flange of the pump or on the outlet-line of the system can be adjusted by potentiometer. The set value for the pressure difference can be found from the curve plate of the pump. The pump will run with variable speed. The reference can be freezed by connecting wire between terminals 5 and 6.

**ATTN** Mark the position of the potentiometer to the sticker in cover of the frequency converter.

### Standard control connections

#### FACTORY DEFAULT: SETUP 2

**SETUP 2 = constant outlet pressure (controller of the frequency converter is in use, FCD)**

**SETUP 1 = speed reference from potentiometer (FCA)**

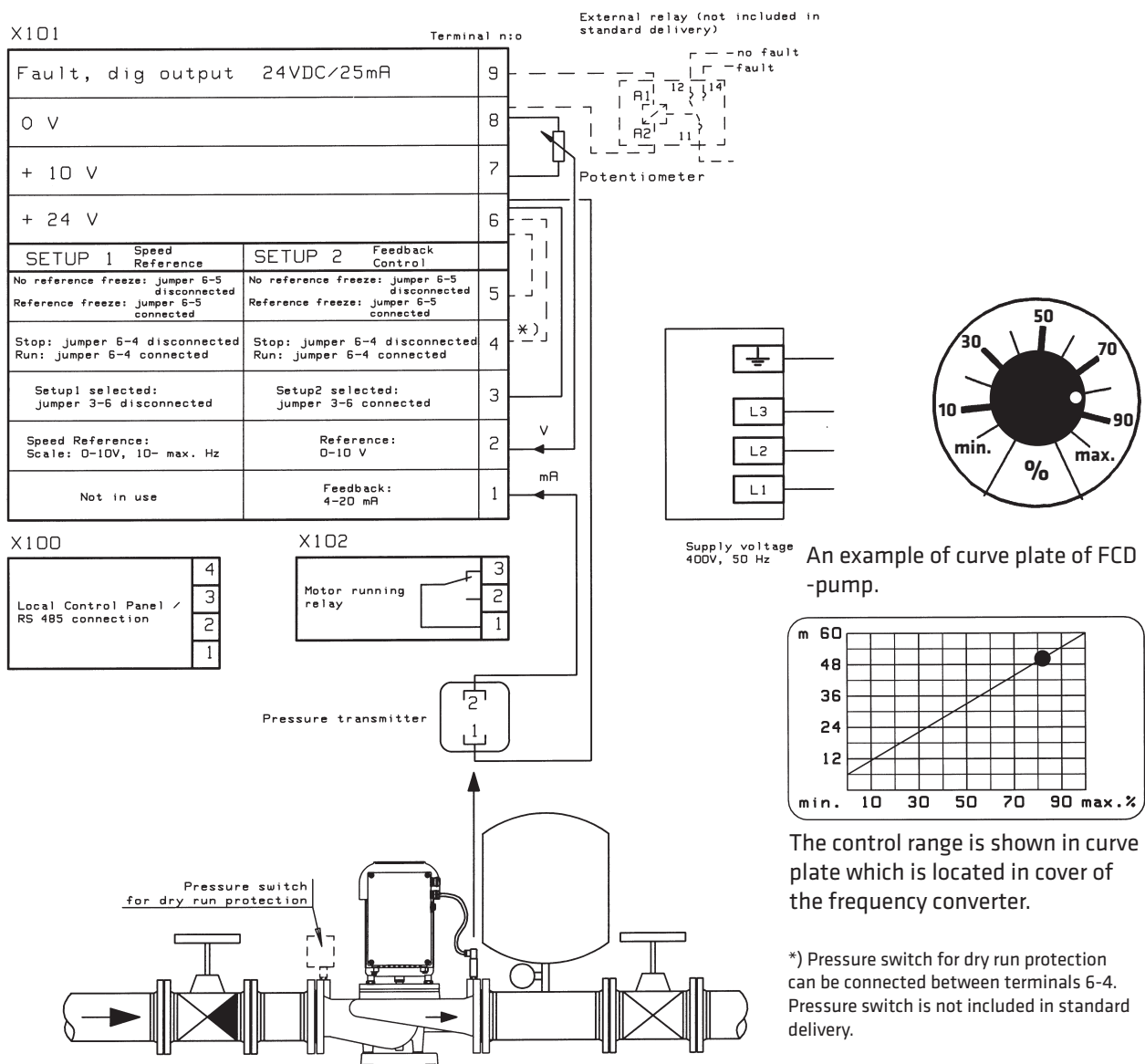

## 5.4.9 FCE -pump - sensorless, pre-programmed pump curves

### Applications

Systems, where are variations in the flow. Heating and cooling circulations and the pressure boosting of parallel circulations.

### Accessories

Pump, frequency converter and potentiometer.

### Operation principle, pump curve and adjusting the flow

The pump curve is selected with potentiometer from the curve plate. The selection is stepless. When adjusting the flow of the system, the main control valve must be opened as open as possible and then the flow is adjusted by potentiometer.

**ATTN** Mark the position of the potentiometer to the sticker in cover of the frequency converter.

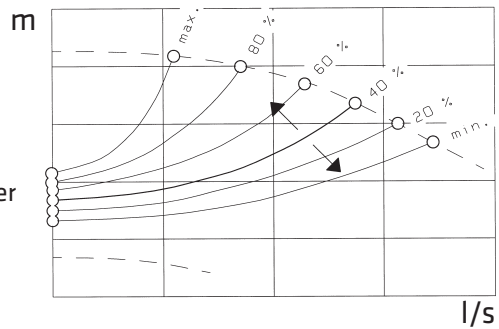

### Standard control connections

**FACTORY DEFAULT: SETUP 2**

**SETUP 2 = variable pressure (FCE)**

**SETUP 1 = speed reference from potentiometer (FCA)**

X101

Terminal n:o	Terminal n:o
Fault, dig output 24VDC/25mA	9
0 V	8
+ 10 V	7
+ 24 V	6
<b>SETUP 1</b> Speed Reference	<b>SETUP 2</b> Sensorless Control (FCE)
No reference freeze: jumper 6-5 disconnected Reference freeze: jumper 6-5 connected	Not in use
Stop: jumper 6-4 disconnected Run: jumper 6-4 connected	Stop: jumper 6-4 disconnected Run: jumper 6-4 connected
Setup1 selected: jumper 3-6 disconnected	Setup2 selected: jumper 3-6 connected
Speed Reference: Scale: 3.1-10V, 10- max. Hz	Pump curve selection: 0-10 V
Not in use	Not in use
	1

External relay (not included in standard delivery)

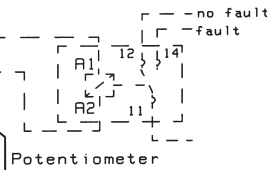

Potentiometer

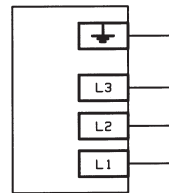

Supply voltage 400V, 50 Hz

X100

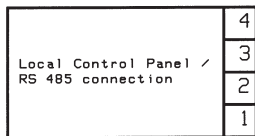

X102

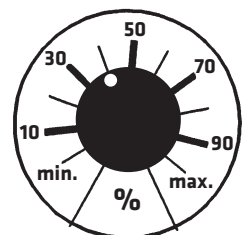
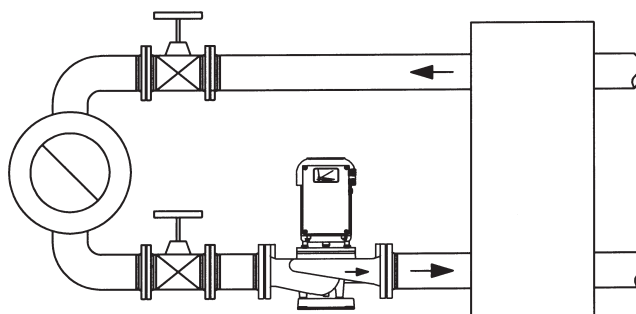
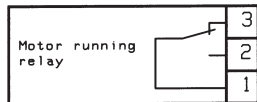

## 5.4.10 FCF -pump - constant temperature

### Applications

Heating and cooling systems, where the constant temperature is required.

### Accessories

Pump, frequency converter, potentiometer, temperature transmitter (and sensor).

### Operation principle

The constant temperature, which is adjusted by potentiometer, is kept up by regulating the flow. The reference can be frozen by connecting wire between terminals 5 and 6.

**ATTN** When ordering the pump, the response of the control must be informed. In the heating system the response is *normal*, in the cooling system *inverse*.

Mark the position of the potentiometer to the sticker in cover of the frequency converter.

### Standard control connections

#### FACTORY DEFAULT: SETUP 2

**SETUP 2 = constant temperature (FCF1, controller of the frequency converter in use)**

**SETUP 1 = speed reference (FCA).**

By disconnecting the jumper between terminals 3-6 (setup1), the pump is running at constant speed (FCA -pump).

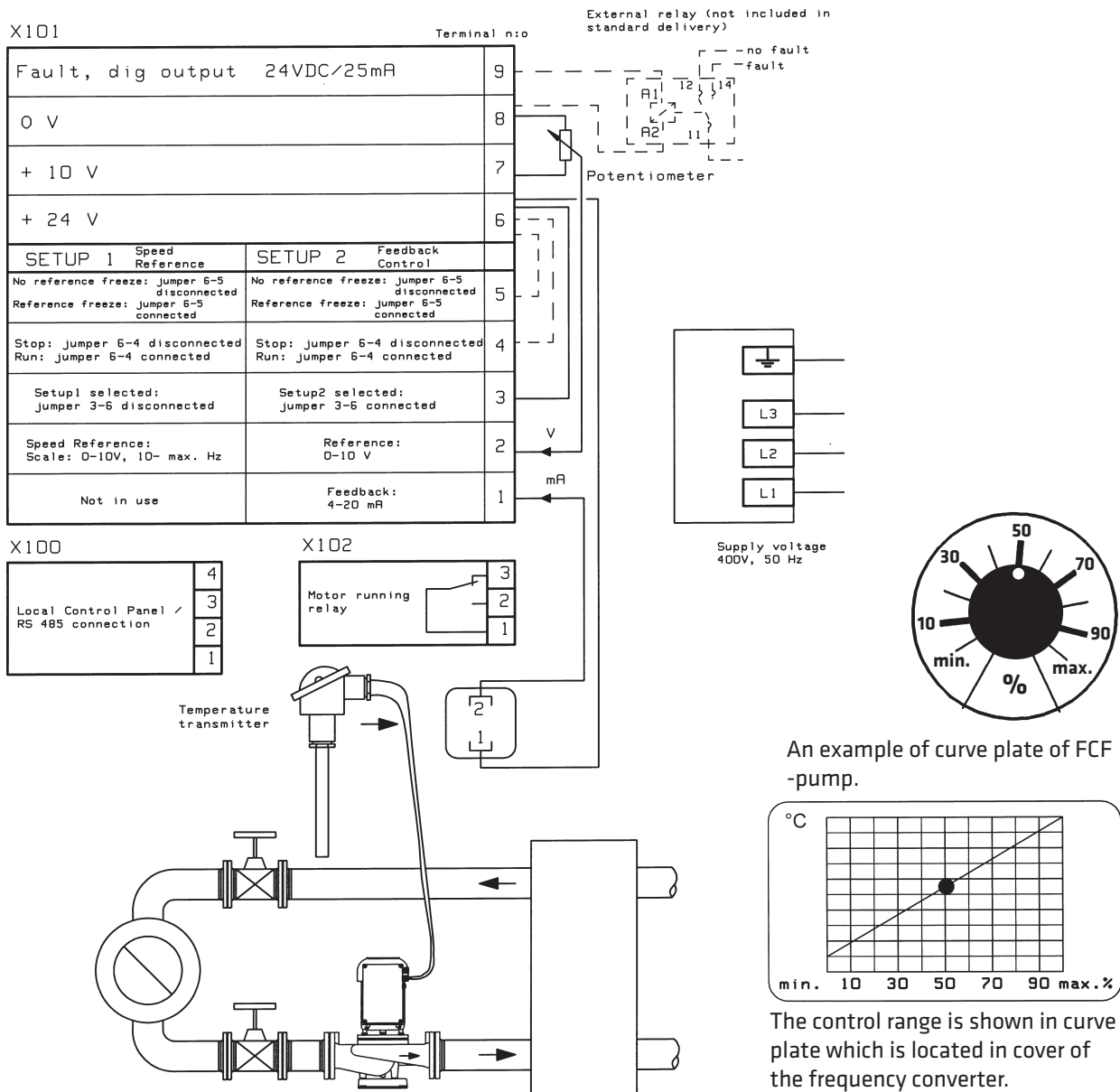

An example of curve plate of FCF -pump.

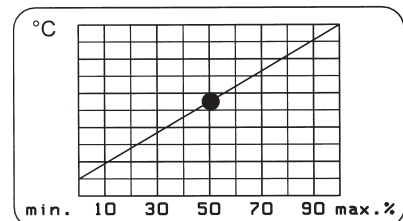

The control range is shown in curve plate which is located in cover of the frequency converter.



## 5.4.11 FCF -pump - the speed according to temperature

### Applications

Heating and cooling systems, where the flow is controlled by temperature.

### Accessories

Pump, frequency converter, potentiometer, temperature transmitter (and sensor).

### Operation principle

The speed reference is given by temperature transmitter.

**ATTN** When ordering the pump, the response of the control must be informed. In the heating system the response is *normal*, in the cooling system *inverse*.

Mark the position of the potentiometer to the sticker in cover of the frequency converter.

### Standard control connections

#### FACTORY DEFAULT: SETUP 2

**SETUP 1 = speed reference (FCA) constant temperature (FCF, controller of the frequency converter in use)**

**SETUP 2 = speed reference according to the temperature (FCF2)**

By disconnecting the jumper between terminals 3-6 (setup1), the pump is running at constant speed (FCA -pump).

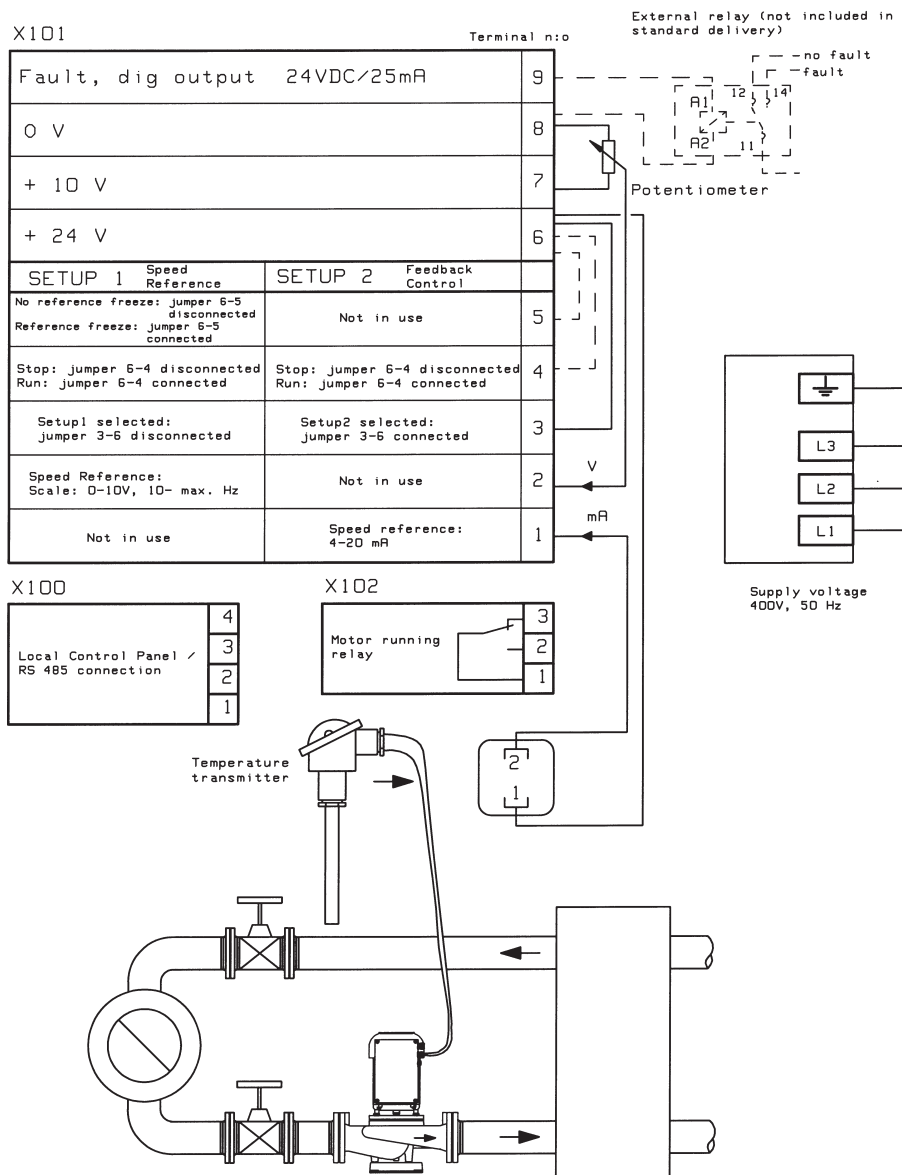

## 5.4.12 FCG -pump - controlled by external system

### Applications

Systems, where are variations in the flow and/or where the flow is controlled mainly with the pump. The pump is controlled by external system or controller.

### Accessories

Pump, frequency converter, potentiometer (for FCA -connections).

### Operation principle

The speed reference for pumps is given from external control system, external controller, process control, etc.

### Standard control connections

#### FACTORY DEFAULT: SETUP 1

**SETUP 1 = speed reference 0-10 V (FCA, from potentiometer or FCG from external controller)**

**SETUP 2 = controller of the frequency converter in use (e.g. FCB, FCC)**

The switch in external control system between terminals 4-6 väliin (e.g. automatic summer stoppage). When pump is delivered from the factory, the wire of the potentiometer is connected to the terminal 2 then the pump can be operated as FCA -pump

X101

Fault, dig output	24VDC/25mA	9	
0 V		8	
+ 10 V		7	
+ 24 V		6	
SETUP 1	Speed Reference	SETUP 2	Feedback Control
No reference freeze: jumper 6-5 disconnected		No reference freeze: jumper 6-5 disconnected	
Reference freeze: jumper 6-5 connected		Reference freeze: jumper 6-5 connected	
Stop: jumper 6-4 disconnected		Stop: jumper 6-4 disconnected	
Run: jumper 6-4 connected		Run: jumper 6-4 connected	
Setup1 selected: jumper 3-6 disconnected		Setup2 selected: jumper 3-6 connected	
Speed Reference: Scale: 0-10V, 10- max. Hz		Reference: 0-10 V	
Not in use		Feedback: 4-20 mA	
		1	

External relay (not included standard delivery)

no fault  
fault

Potentiometer

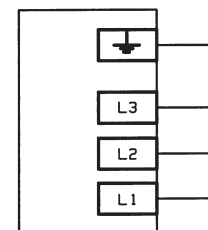

Supply voltage  
400V, 50 Hz

External speed reference  
+ 0-10V

\*) When pump is delivered from the factory, the wire of the potentiometer is connected to the terminal 2 then the pump can be operated as FCA -pump. By disconnecting the wire and connecting the external voltage signal to the terminal 2, the pump is controlled externally.

X100

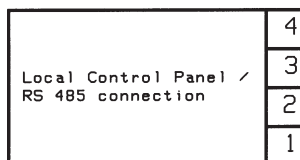

X102

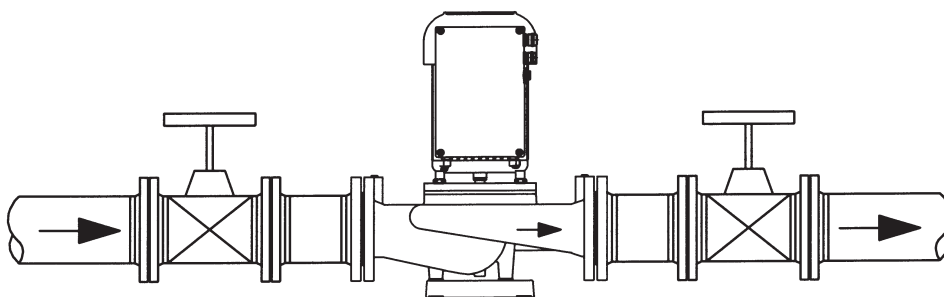
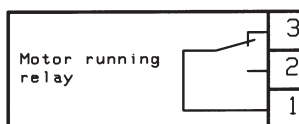

### 5.4.13 Connections to the alarm receiving station

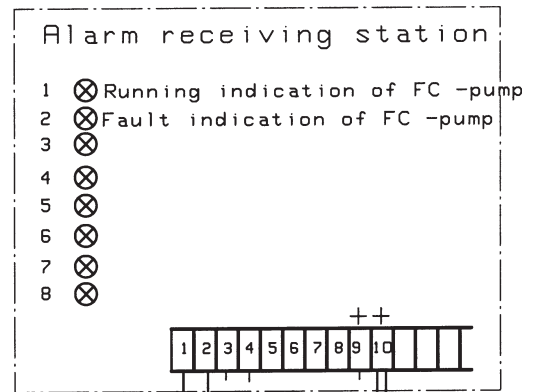

External relay for fault indication:  
 eg. Kolmeks (code RELEPLC) 24 VAC/VDC /9mA,  
 change-over contacts, to be installed to the separate electrical  
 cabinet. Fault activates when there is fault in frequency converter  
 (voltage between terminals 8-9/X101).

Relay for running indication:  
 Terminals 1-2/X102 are connected when pump is running.

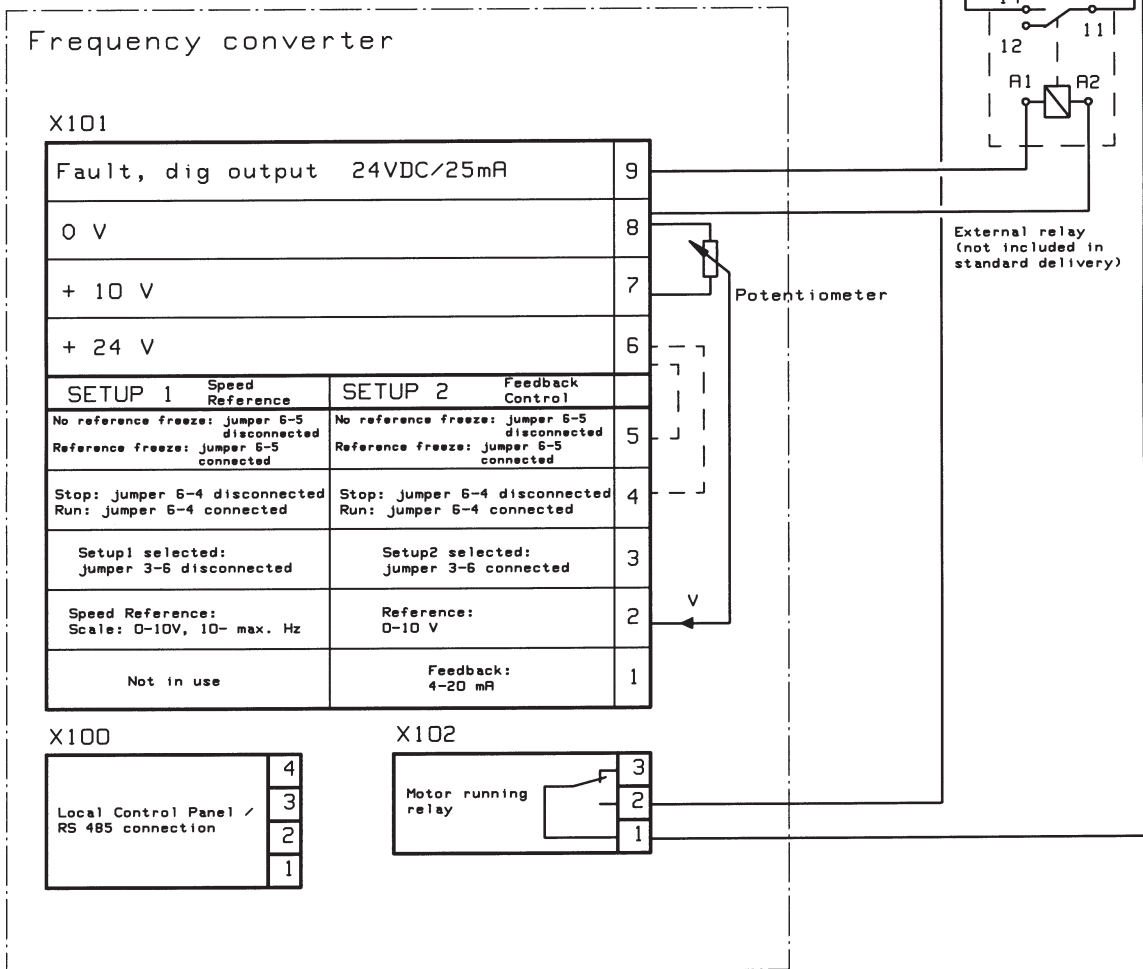

## 5.4.14 Local control panel (optional)

The FC\_ -pump optionally features a Local Control Panel - LCP, which makes up the complete interface for operation and monitoring of the FC\_ -pump.

### LCP installation

LCP is connected to the terminal X100, 1-4

### LCP functions

The functions of the control panel can be divided into three groups:

- display
- keys for changing program parameters
- keys for local operation

All data are indicated by means of 4-line alpha-numeric display, which in normal operation is able to show 4 measurements and 3 operation conditions continuously. During programming, all the information required for quick, effective parameter setup of the FC\_ -pump will be displayed. As a supplement to the display, there are three LEDs for voltage, warning and alarm. All programming parameters of the FC\_ -pump can be changed immediately from the control panel, unless this function has been blocked via parameter 018.

Control panel is connected to these terminals

Reference, value of potentiometer (or other value which is defined in parameter 010))

Motor current or other value which is defined in parameter 011

Feedback value or other value which is defined in parameter 012

Frequency or other value which is defined in parameter 009. Active warnings and alarms.

Mode.  
Normal:  
REM RUN OK

**DISPLAY STATUS** - changes the first line from headline to analog values. If button is hold, the titles of the analog values are shown: REF. , CURR. , FEEDB. eference, motor current and feedback)

With **MENU** button the parameter mode is selected.

With **OK** button the changes are confirmed. Sometimes the change is confirmed without pushing **OK**.

With **CANCEL** button you'll get back without confirming the changes, if **OK** is not pushed.

By pushing **CHANGE DATA** button the submenu of parameter setup is selected.

**START** button. FC-pump must be left to **RUNNING MODE** before disconnection of control panel!!

After pushing **MENU** button, parameter group 0 ... 9 are selected with these **narrow buttons** or after pushing **CHANGE DATA** button the required decimal is selected with these narrow buttons.

With **+/-** buttons the large reading can be selected. 23 different option eg. the feedback mA or reference V also motor power, current, temperatures etc. Parameters are selected with **+/-** button after pushing **MENU** button and selection parameter group with narrow buttons. After pushing **CHANGE DATA** button with **+/-** buttons is the new value of the parameter selected

Active setup. Setup1 speed reference (A- or G-version ), Setup2 Reference control ( B,C,D)

ALARM WARNING ON

STOP RESET JOG FWD REV START

7.936U 0.00kW 7.722U  
27.0Hz SETUP 2

DISPLAY STATUS QUICK MENU MENU  
CHANGE DATA CANCEL OK

+

-

## Examples

### Checking of the duty poin of the pump:

Push **DISPLAY STATUS** button once and read the values of first line.

Normally the first value is reference, the second is motor current and the third is feedback (if the setup 1 is selected the third value is power). If **DISPLAY STATUS** is hold, the titles of the analog values are shown. ( REF. (reference), CURR. (motor current) and FEEDB. (feedback)

### Checking and changing of the numerical parameter:

e.g. swithing frequency from 8000 Hz to 7000 Hz ( parameter No 411 ).

Push **MENU** button once, then the number of the parameter group is on the bottom line.

If necessary push narrow buttons until required group (4..) is selected.

Push + or - buttons until parameter 411 is on the bottom line. Also the present value is shown.

Push **CHANCE DATA** button to select the parameter changing mode.

Move the flashing cursor with narrow buttons to the digit which is to be changed. Change the digit with + or - buttons.

The new value becomes effective immediately, but the selection must be confirmed with OK button. Push **DISPLAY STATUS** button to return to the first display.

### Checking and changing of the text parameter:

e.g. parameter 437 changing from **NORMAL** to **INVERSE** (application: temp. control in cooling system).

Push **MENU** button once, then the number of the parameter group is on the bottom line.

If necessary push narrow buttons until required group (4..) is selected.

Push + or - buttons until parameter 437 is on the bottom line. Also the present value is shown.

Push **CHANCE DATA** button to select the parameter changing mode.

Change the value with + or - buttons. Confirm the selection with OK button.

**ATTENTION!** All parameters are not allowed to change without stoppage of the pump with **STOP RESET** button.

After changing parameters start the frequency converter always with **START** button.

### Checking of the analog mA -value of the feedback transmitter (terminal N:o 1):

In first display (if necessary push first **DISPLAY STATUS**) push + or - buttons until to the first line comes the text ANALOG INPUT 1. The large value in display is the mA -value of the feedback transmitter. The value must be over 4 mA lower than 20 mA in the normal situation. In the same way is checked the reference V -value ANALOG INPUT 2. The value must be over 0 V but lower than 10 V in the normal situation.

### Checking of fault log (parameter 615):

Push MENU button once, then the number of the parameter group is on the bottom line.

If necessary push narrow buttons until required group (6..) is selected.

Push + or - buttons until parameter 615 is on the bottom line.

Push CHANCE DATA button to select the parameter reading mode.

## 6. Service, spare parts and troubleshooting

The pump doesn't need any regular servicing. As a shaft seal is used an adjustment free mechanical seal. It is a wearing part which has to be replaced if it starts to leak. Note that few drops leakage per hour can be quite normal especially when coolants (f.ex. glycol) are pumped.

### 6.1 Shaft seals

Pump type	Shaft mm	O-ring / gasket mm
AE_-25/-26 FC_	12	123x2,5
L-32A FC_	12	100x2,5
L_-40A, AL_-1032, AE_-32/-33 FC_	12	145x2,5
L_-50A, AL_-1054 FC_	12	150x3
L_-50C, AL_-1055 FC_	18	150x3
L_-65A, L_-65B, AL_-1065, -1066, L_-80A, AL-1081, -1102 FC_ 18	179,3x5,7	
AL_-1106, -1129 FC_	32	309/295x1

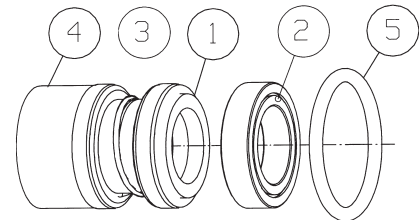

- 1 Rotating ring
- 2 Stationary ring
- 3 Body / bellows
- 4 Spring
- 5 O-ring

The motor is equipped with ball bearings which are lubricated for life and therefore do not need any service. In the case of any motor malfunction it is recommended to replace the whole motor unit.

### 6.2 Other parts

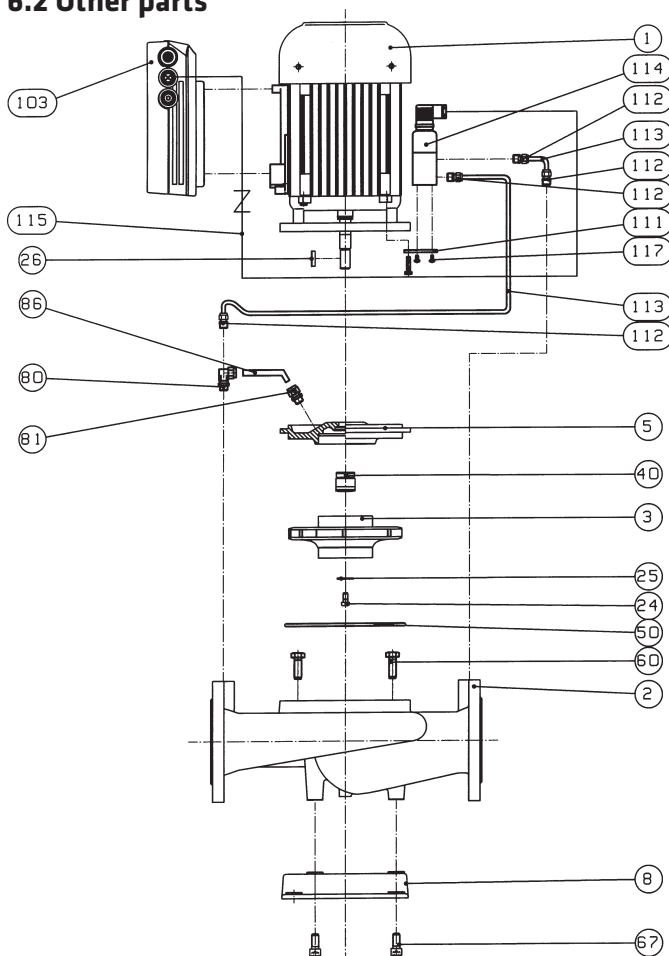

- 1 Electric motor
- 2 Pump housing
- 3 Impeller
- 5 Sealing flange
- 8 Foot (not always)
- 24 Screw or nut
- 25 Washer
- 26 Key
- 40 Shaft seal
- 50 O-ring or gasket
- 60 Screw or nut
- 67 Screw
- 80 Pipe union (L- and ALH -serie)
- 81 Pipe union (L- and ALH -serie)
- 86 Cooling pipe (L- and ALH -serie)
- 103 Frequency converter
- 111 Fixing plate (FCB, FCC)
- 112 Pipe joints (FCB, FCC)
- 113 Pipes (FCB, FCC)
- 114 Transmitter for pressure, pressure difference or temperature (FCB, FCC, FCD, FCF)
- 115 Cable (FCB, FCC, FCD, FCF)
- 117 Screws (FCB, FCC)



**WHEN ORDERING SPARE PARTS, PLEASE SPECIFY THE TYPE IDENTIFICATION, SERIAL NUMBER, THE SIZE OF THE IMPELLER, THE MOTOR TYPE AND POWER AND THE POSITION NUMBER OF THE SPARE PART.**

## 6.3 Troubleshooting

Trouble	Fault	Fixing
<p><b>Shaft seal is leaking.</b></p>	<p>Wearing.</p> <p>Pump has run dry.</p>	<p>Change the seal.</p> <p>Change the seal.</p>
<p><b>Pump don't run.</b></p>	<p>The shaft of the pump is blocked.</p> <p>Fuses have worked.</p> <p>No electricity.</p> <p>The disorder has stopped the pump.</p> <p>Control wiring is not correct.</p> <p>The parametres of the frequency converter are changed or the pump is stopped with local control panel.</p> <p>The frequency converter or electric motor is damaged.</p> <p> If the pump is operated when cover of the frequency converter is open, the special carefullness must be observed.</p>	<p>Check the free rotation of the shaft by turning the motor fan. If required, loosen the motor unit from the pump housing and repair the cause of the block.</p> <p>Repair the cause of the fault. Change the fuses. If necessary, call the expert.</p> <p>Check and repair connections. If necessary, call the expert.</p> <p>Reset the pump by disconnecting the supply voltage at least for 10 seconds.</p> <p>Check the wiring in accordance with the control diagram. Between terminals 4-6 must be jumper or closed switch.</p> <p>Correct the parameters or start the pump with the local control panel (not included in standard delivery). If necessary, call the expert.</p> <p>Replace the frequency converter and/or electric motor with a new one. Contact to Kolmek.</p>
<p><b>Pump stops by itself or runs irregular and noisy.</b></p>	<p>The supply voltage is defective. One phase is possible missing.</p> <p>The frequency converter or electric motor is damaged.</p>	<p>Check the supply voltage. Check and repair fuses and connections of the cables.</p> <p>Replace the frequency converter and/or electric motor with a new one. Contact to Kolmek.</p>

Trouble	Fault	Fixing
<p><b>The pump is running with minimum frequency.</b></p>	<p>The reference value is missing or in minimum.</p> <p>The pipes of the pressure or differential pressure transducer are blocked or incorrectly connected.</p> <p>The signal of the feedback transmitter (pressure or temperature) is too high. Possible short circuit.</p> <p>The mechanical or electrical connections of the temperature transmitter of the FCF -pump are incorrect or the transmitter is damaged.</p> <p>Parameters of the FCF -pump are wrong. (cooling and heating pumps have different parameters)</p> <p>The incorrect setup selection or wrong parameters.</p>	<p>Adjust the correct value with the potentiometer (if intention to use the potentiometer as source of the reference signal). Check the wiring of the potentiometer. Check and correct the reference if the reference is given by external controller.</p> <p>Check and repair the connections and blockings of the pipes. Open the possible valves, which are installed to the pipes.</p> <p>Disconnect the cable from the transmitter, the speed should increase, if there is a fault in transmitter or the signal. Check the connections, transmitter. If necessary, replace the transmitter with the new one.</p> <p>Check and repair of the connections or the transmitter.</p> <p>Check and correct the parameters with the local control panel. If necessary, call the expert.</p> <p>Check the selected setup. Terminals 6-3 closed = setup2, opened = setup1. Check and correct the parameters with the local control panel. If necessary, call the expert.</p>
<p><b>The pump is running only with the maximum frequency, which don't vary in accordance with the requirements of flow changes.</b></p>	<p>Reference signal is too high.</p> <p>Feedback transmitter is missing or the signal is wrong.</p> <p>The pipes of the pressure or differential pressure transducer are blocked or incorrectly connected.</p>	<p>Adjust the correct value with the potentiometer (if intention to use the potentiometer as source of the reference). Check the wiring of the potentiometer.</p> <p>Check and correct the reference if the reference is given by external controller.</p> <p>Check and repair the feedback signal and/or connections. If necessary, replace the transmitter with the new one.</p> <p>Check and repair the connections and blockings of the pipes. Open the valves, which may be installed to the pipes.</p>



Trouble	Fault	Fixing
<p><b>The pump is running only with the maximum frequency, which don't vary in accordance with the requirements of flow changes.</b></p>	<p>The mechanical or electrical connections of the temperature transmitter of the FCF -pump are incorrect or the transmitter is damaged.</p> <p>Parameters of the FCF -pump are wrong. (cooling and heating pumps have different parameters)</p> <p>The incorrect setup selection or wrong parameters.</p> <p>The maximum speed is required by the system.</p>	<p>Check and repair of the connections or the transmitter.</p> <p>Check and correct the parameters with the local control panel. If necessary, call the expert.</p> <p>Check the selected setup. Terminals 6-3 closed = setup2, opened = setup1. Check and correct the parameters with the local control panel. If necessary, call the expert.</p> <p>Check the adjustments and the need of the pumping in the system. Balance the parallel circulations. It can be the normal situation, then there is no need for any further measures. Solve the actual rotation speed by measuring or with the local control panel. Contact to Kolmek. Maximum frequency is not allowed to change (factory default).</p>

Green LED 302	Yellow LED 301	Red LED 300	Operation
off	off	off	Connect the supply voltage.
on	off	off	Connect the start and reference signal
on	off	on	Disconnect the supply voltage as long as all LEDs are off.
on	on	on	Disconnect the supply voltage as long as all LEDs are off.

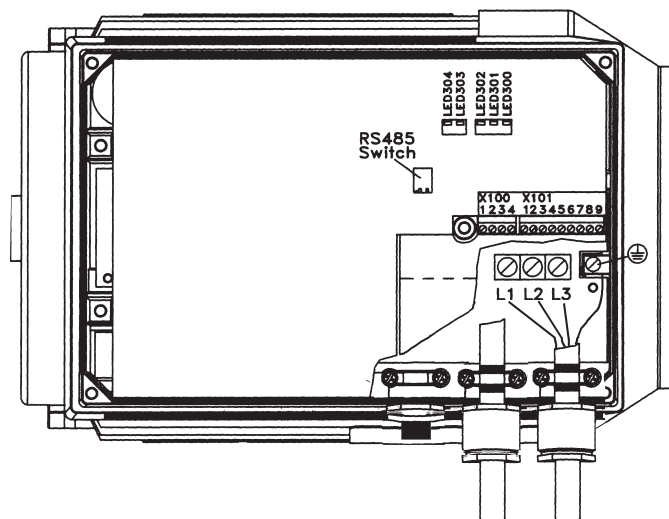

Trouble	Fault	Fixing
<p><b>The pump is not pumping.</b></p>	<p>There is air in the pump or the system.</p> <p>The suction pressure is too low.</p> <p>Circulation is closed with the valves</p>	<p>Deairate the system. Fill the pumps and the pipes with the fluid. Try to run the pump a moment with the high speed, then possible air pockets leave the system easier.</p> <p>Increase the suction pressure.</p> <p>Open the valves.</p>
<p><b>The pump is noisy.</b></p>	<p>Cavitation.</p> <p>The pressure difference of the pump is too high.</p> <p>There is a faulty shaft seal or bearings.</p> <p>Electrical noise from the frequency converter or electric motor.</p>	<p>Increase the suction pressure. Decrease the flow.</p> <p>Decrease the pressure reference. If possible, open the control valves and decrease the pressure reference, then the head of the pump is lower and the flow remains the same.</p> <p>Continuous rough noise refers to the faulty bearings. High noise, few seconds long, occasionally refers to the faulty shaft seal. Replace faulty bearings and shaft seal with the new ones. If necessary, contact Kolmek.</p> <p>Replace the motor with the new one. If necessary, correct the parameters of the frequency converter. Contact Kolmek.</p>

## 7. Declaration of Conformity

We, OY KOLMEKS AB, P.O.Box 27 FI-14201 Turenki, FINLAND

declare under our sole responsibility that the products

### **FC\_ - PUMP SERIE,**

types AE, AEP, L, LH, LP, LS, AL, ALH, ALP, ALS, T and AT,

to which this declaration relates, are in conformity with the

- Council Directive 98/37/EY on the approximation of the laws of the Member States relating to machinery
- Low voltage directive 2006/95/EY
- Pumps and pump units for liquids. Common safety requirements. EN 809.

### **EMC STANDARDS**

Generic standards

The generic standards are stated in the EMC directive (89/336/ETY).

FC\_ -pump complies with:

*EN 50081-1<sup>1)</sup>, EN 50082-1.*

Residential, commercial and light industrial environment.

*EN 50081-2, EN 50082-2.*

Industrial environment.

- <sup>1)</sup> Emission levels stated by EN 50081-1 are only fulfilled by FC\_ -pumps with class B-1 optional filter. Class B-1 filter is included in FC\_ -pumps as a standard.

Turenki 04.01.2010



Kimmo Issakainen  
Managing Director

### **KOLMEKS LTD**

P.O.BOX 27 FI-14201 TURENKI, FINLAND

tel. +358 20 7521 31

fax +358 20 7521 200

[www.kolmeks.fi](http://www.kolmeks.fi)

[export@kolmeks.fi](mailto:export@kolmeks.fi)